

Article number: 20165B252BL

Description: E+G

Base plate clamp GN165-B25-2-BL

Measures

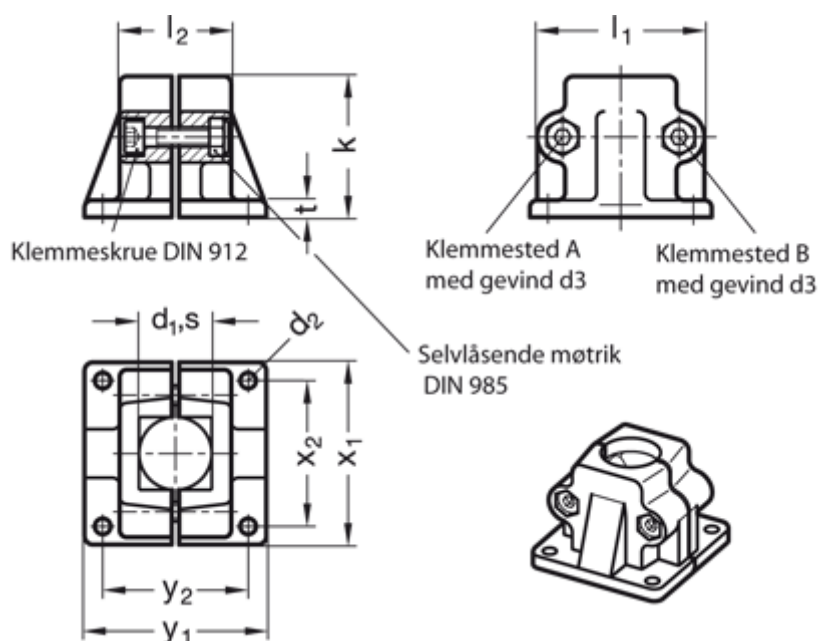

Adjustable clamp lever = GN 911-M10-63 have to be ordered separately

d1	= B40
d2	= 11
d3	= M10
k	= 91
l1	= 98
l2	= 70
t	= 14

x1	= 115
x2	= 90
y1	= 119
y2	= 90